

V-22 Osprey Pocket Guide

BELL BOEING V-22 PROGRAM OFFICE
Amarillo, Texas
806-341-3200

Please visit our websites at:
www.bellhelicopter.com
www.boeing.com



MPD07-64214-001

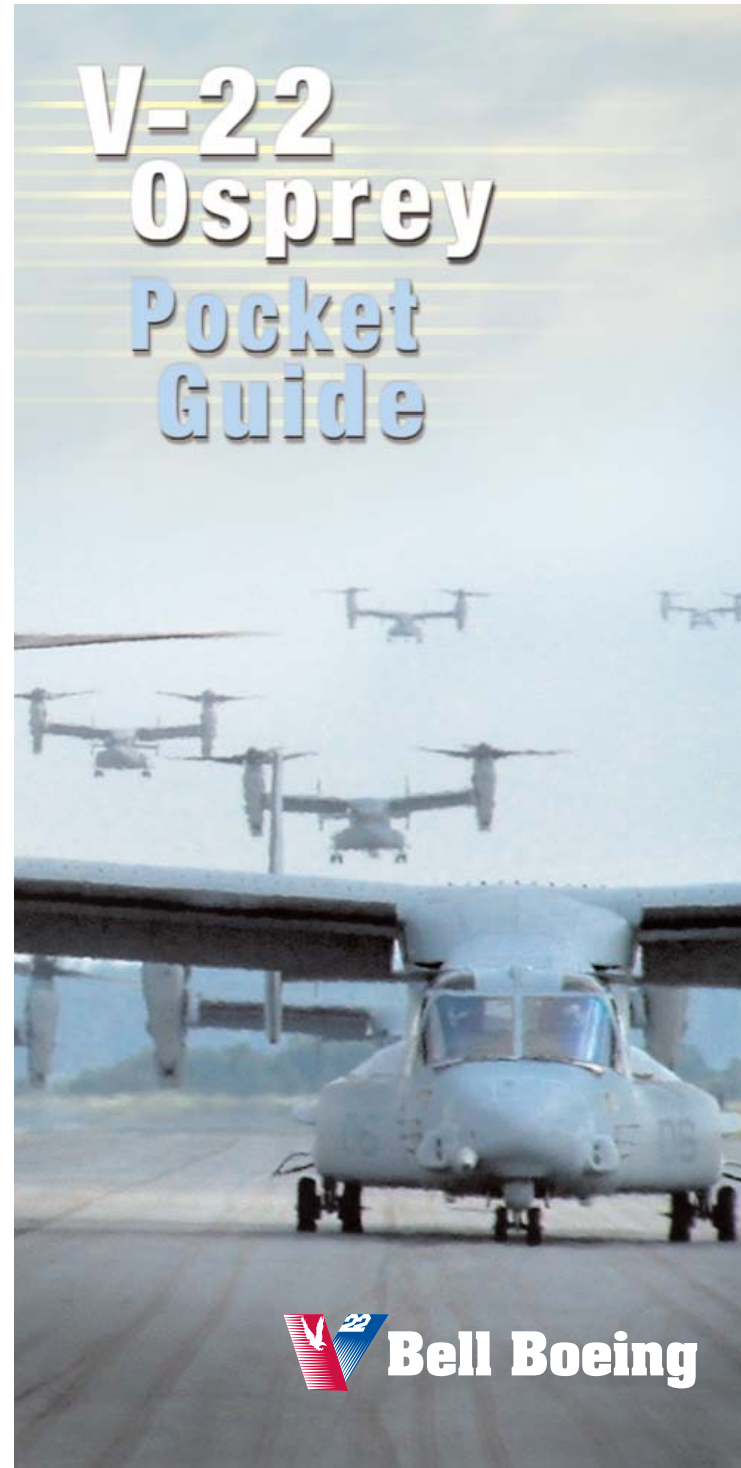

V-22 Osprey

Pocket Guide



© 2007 Bell Boeing
Approved for Public Release
NAVAIR Control Number 021-07



Table of Contents

Introduction	.1
Program Events	.2
Background/History	.4
General Characteristics	.5
Design Features	.6
Airframe	.6
Landing Gear	.8
Propulsion System	.9
Payload Systems	.10
Flight Control System	.15
Hydraulic Systems	.20
Electrical Systems	.21
Fuel System	.22
Environmental Systems	.23
Pneumatic Systems	.23
Cockpit and Avionics	.23
Shipboard Compatibility	.26
Survivability Features	.28
Operating Environment	.30
Performance	.32
Multiservice Configurations	.34
V-22 Top Tier Suppliers	.37
Studies and Analyses	.38
Pilot Training	.40
Multimission Capabilities	.42

Introduction

The V-22 Osprey is the world's first production tiltrotor aircraft. Unlike any aircraft before it, the V-22 successfully blends the vertical flight capabilities of helicopters with the speed, range, altitude, and endurance of fixed-wing transports. This unique combination provides an “unfair advantage” to warfighters, allowing the conduct of current missions more effectively, and the accomplishment of new missions, heretofore unachievable with legacy platforms.

Comprehensively tested and approved for full rate production, the V-22 provides strategic agility, operational reach, and tactical flexibility - all in one survivable, transformational platform.



Background/History

Both Bell and Boeing have over 50 years of experience in V/STOL aircraft design. In 1956, Boeing began development of the world's first tiltwing aircraft the VZ-2. Its maiden flight was in 1958.



VZ-2 (1958)

Concurrently, Bell's research had focused on tilting the transmissions to achieve the conversion to conventional flight. Bell's XV-3 tiltrotor (begun in 1954) successfully achieved full conversion from helicopter to airplane mode in 1958. It continued in flight test until 1966 and did much to demonstrate the feasibility of tiltrotor technology.



XV-3 (1958)

In the 1960s and 1970s, Boeing completed over 3,500 hours of wind-tunnel testing of tiltrotor models. These models included a full-scale rotor system. Based on its experience with the XV-3, Bell was awarded a NASA-U.S. Army contract (in 1973), to develop two XV-15 tiltrotors. Its first flight occurred in 1977 and full conversion occurred in 1979. The two XV-15s demonstrated the maturity of tiltrotor technology and were directly responsible for the birth of the Joint Services Advanced Vertical Lift Aircraft (JVX).



XV-15 (1977)

Drawing upon the strengths of their respective research efforts during the preceding 30 years, the Bell-Boeing team was officially formed in April 1982. In April 1983, the U.S. Navy selected the Bell-Boeing team as the prime contractor to develop the JVX aircraft – now known as the V-22 Osprey.

The V-22 was approved for full-rate production in 2005, with initial operational capability in 2007. Projected production quantities are 360 for the U.S. Marine Corps, 50 for U.S. Special Operations Command (operated by the Air Force Special Operations Command), and 48 for the U.S. Navy.



V-22 (1989)

Program Events

Activity	Date
JVX Program Commenced	1981
Bell-Boeing Team Formed	Apr 82
Bell-Boeing Awarded 24-Month JVX Preliminary Design Stage I Contract	Apr 83
Bell-Boeing Awarded JVX Preliminary Design Stage II Contract	Jun 84
FSD Contract Award	May 86
V-22 First Flight	Mar 89
Awarded Collier Trophy	1990
EMD Contract Award	Oct 92
ADM Signed for MV-22/CV-22 Program	Feb 95
Authorized to Proceed with CV-22 EMD	Dec 96
LRIP Lots I, II, III Contract Award	Jun 96
EMD V-22 First Flight	Feb 97
Completed Sea Trials	Feb 99
V-22 Pilot Team Wins AHS Feinberg Award	Apr 99
Receives 1999 DoD Defense Value Engineering Award	Apr 99
Operational Flight Training Simulator Delivered to VMMT-204	Apr 99
Lightweight 155mm Howitzer Lifted Externally	May 99
First Production V-22 Delivered to USMC	May 99
VMMT-204 (MV Training Squadron)	Jun 99
V-22 Completes Initial OPEVAL (pre Block A)	Sep 00
Live Fire Test and Evaluation	Nov 00
Operational Pause	Dec 00
Return to Flight	May 02
VMX-22 Standup (MV Operational Test and Evaluation Squadron)	Aug 03
V-22 ITT Wins AHS Grover Bell Award	Jun 04
71 st SOS Standup (CV Training Squadron)	May 05
V-22 Completes Final OPEVAL (Block A)	Jun 05
V-22 Approved for Full Rate Production	Sep 05
VMM-263 Standup (1 st MV Combat Squadron)	Mar 06
75 th MV-22 Delivery	Jun 06
VMM-162 Standup (2 nd MV Combat Squadron)	Aug 06
1 st Transatlantic Flight	Jul 06
8 th SOS Standup (1 st CV Operational Squadron)	Oct 06
VMM-266 Standup (3 rd MV Combat Squadron)	Mar 07

General Characteristics

Performance @ 47,000 lb

Max cruise speed (MCP) Sea Level (SL), kts (km/h)	250 (463)
Max RC, A/P mode SL, fpm (m/m)	3,200 (975)
Service Ceiling, ISA, ft (m)	25,000 (7620)
OEI Service Ceiling ISA, ft (m)	10,300 (3139)
HOGE ceiling, ISA, ft (m)	5,400 (1,646)

Weights

Takeoff, vertical, max, lb (kg)	52,600 (23859)
Takeoff, short, max, lb (kg)	57,000 (25855)
Takeoff, self-deploy, lb (kg)	60,500 (27443)
Cargo hook, single, lb (kg)	10,000 (4536)
Cargo hook, dual, lb (kg)	15,000 (6804)

Fuel Capacity

MV-22, gallons (liters)	1,721 (6513)
CV-22, gallons (liters)	2,037 (7710)

Engines

Model	AE1107C (Rolls-Royce Liberty)
AEO VTOL normal power, shp (kW)	6,150 (4586)

Crew

Cockpit – crew seats	2 MV/3 CV
Cabin – crew seat/troop seats/litters	1/24/9

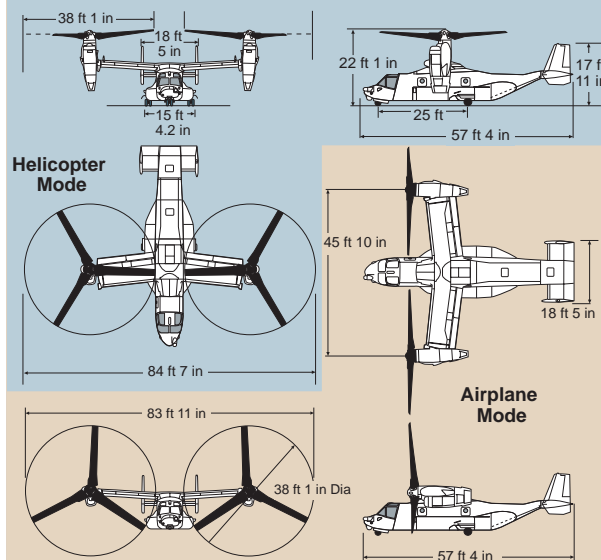

Design Features

The V-22 has been designed to the most stringent set of design requirements of any rotary wing aircraft ever built, including safety, reliability, readiness, all-weather operations, survivability, crash worthiness, and performance.

The ability to rapidly carry large payloads over long distances and its self-deployability make the V-22 capable of supporting numerous missions worldwide.

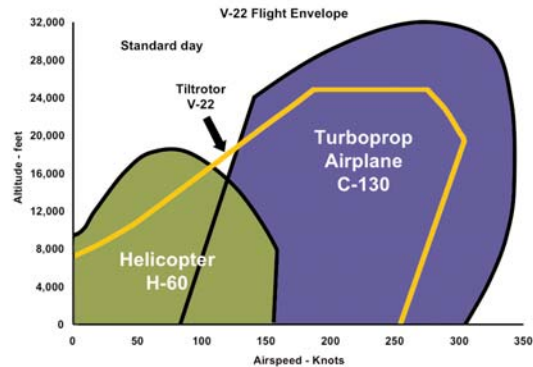

- | | | |
|---|---------------------------------|---|
| <ul style="list-style-type: none"> • Sustained cruise speed: 250+ knots • Self-deploy worldwide • Unrefueled radius of action: 500+ nmi | } Fixed-wing tactical transport | <ul style="list-style-type: none"> • High level of ballistic tolerance • Cockpit integrated color displays, avionics to navigate worldwide, civil and military fields |
| <ul style="list-style-type: none"> • Operate from amphibious ships • Hover hot and high • Carry 15,000 lb external payload • Vertical insertion/ extraction | } Helicopter assault transport | <ul style="list-style-type: none"> • Fold/stow and corrosion protection to meet shipboard compatibility |

Top Level V-22 Design Requirements

Airframe

A key enabling technology for the development of the V-22 was the use of composite materials to reduce cost and weight, improve reliability, and increase ballistic tolerance. The past two decades of extensive research and development on composite materials in the aerospace industry has directly benefitted the V-22 structural design.

Modular construction

- Large structural assemblies: forward fuselage, center fuselage, aft fuselage, ramp, empennage, wing, and nacelles

Airframe material

- Aluminum major frames with graphite/epoxy (fabric and unidirectional prepregs) subframes, skins, and main landing gear door

Airframe construction

- Machined aluminum and composite frames/stiffened skins/molded longerons

Mechanical fasteners

- Subassemblies and skins assembled with compatible titanium fasteners

Major honeycomb components

- Cockpit and cabin floors, sponsons (fuel tanks and ECS compartment), fairings and select airframe components

Major fittings

- Predominantly metal: steel, titanium, and aluminum

Lightning protection

- Continuous metal mesh molded into outside surface of fuselage

Transparencies

- Windshield: laminated acrylic/polycarbonate
- Canopy and side windows: laminated hard coat/hard coat polycarbonate .

Structural Features

More than 43 percent of the V-22 airframe structure is fabricated from composite materials. The wing is made primarily with IM-6 graphite/epoxy solid laminates that are applied unidirectionally to give optimum stiffness. The fuselage, empennage, and tail assemblies have additional AS4 graphite fiber materials incorporated during their fabrication. Many airframe components (such as stiffeners, stringers and caps) are co-cured with the skin panels. This technique provides subassemblies with fewer fasteners, thus fewer fatigue effects.

The composite airframe delivers the necessary stiffness and light weight for V/STOL. It also provides additional resistance to environmental corrosion caused by salt water. The composite airframe is fatigue resistant and damage tolerant – a feature particularly desirable for ballistic survivability.

Landing Gear

The retractable tricycle landing gear is a crashworthy design that allows routine operations over field conditions consisting of rocks, sand, dust, dirt, grass, brush, snow, rain, and ice. Its clearance for boulders and stumps is up to 30.5 cm (12 in).

Design highlights include:

- Main landing gear
 - Two hydraulically activated main landing gear located in the left and right sponsons
 - Hydraulic master braking cylinders
 - Manually-activated, cable-operated parking brake
- Steerable nose landing gear
 - Hydraulically activated located under the cockpit floor
 - Hydraulic power steering unit provides 75 degree left and right steering authority, which is controlled by the rudder pedals.
- A 19.3 mPa (2800 psi) nitrogen bottle provides emergency extension power.
- Descent conditions
 - 3.7 m/s (12 ft/s) for normal operations
 - 7.3 m/s (24 ft/s) during a crash landing
- Landing gear loading
 - Designed for a California Bearing Ratio (CBR) of 4.0

Weight distribution	kg	lb
Main landing gear (ea)	5,595	12,337
Nose gear	4,202	9,264
Footprint area, per tire	sq cm	sq in
Two mains, (ea)	348	54
Nose wheels	116	18
Footprint pressure	kPa	psi
Main landing gear (ea)	827	120
Nose gear	1,860	270

Landing gear loading at the aircraft empty weight in helicopter mode at the one g static condition

Propulsion System

Two Rolls-Royce AE1107C Liberty engines provide the propulsion for the V-22. The AE1107C is a 6,150 shaft horsepower, two-spool, turboshaft, gas-turbine engine. The engines are located within the nacelles. The interconnect driveshaft provides safe one-engine-out flight in all modes of operation.

An Engine Air Particle Separator (EAPS) is integral to the engine installation, and can be selected to manual pilot control or automatic.

Fire detection and extinguishing systems are provided in the engine compartments, wing bays and mid-wing areas.

A rotor brake assembly is integral to the mid-wing gearbox.

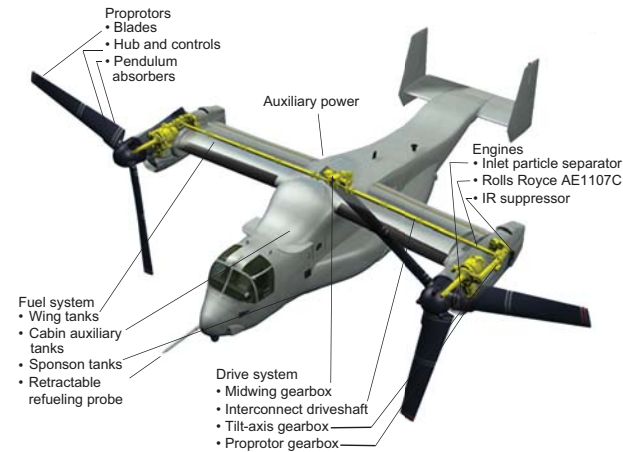

Propulsion System Components

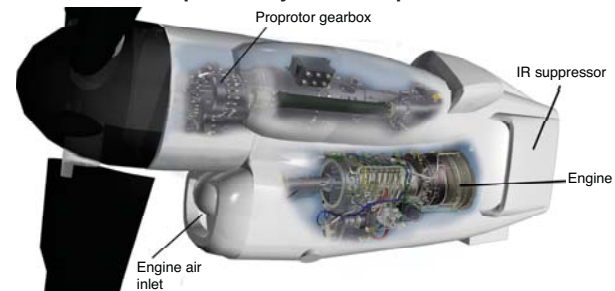

Engine Nacelle

Payload Systems

The V-22 is designed to fulfill the multimission role, with its large open cabin, rear loading ramp, and a variety of cabin and cargo systems.

Personnel transport

- Crashworthy seats
 - Crew chief and 24 troops
 - Folding, removeable seats for loading flexibility
 - Inboard facing
- Medevac litter stanchions
 - Up to three stations of (3) litter positions each

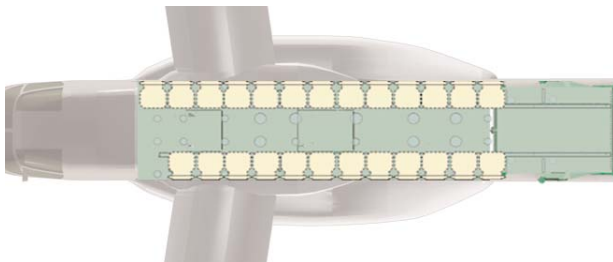

Cabin Seating

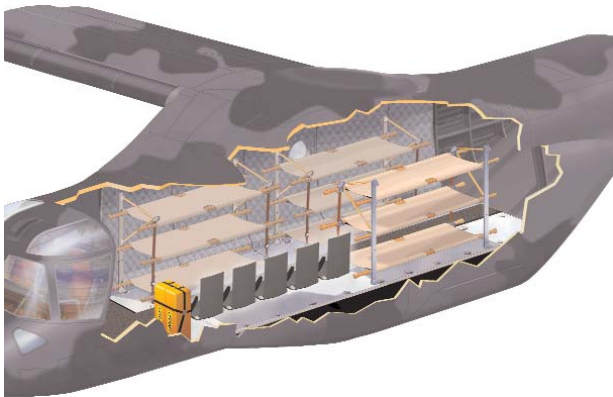

MEDEVAC Cabin Configuration



Cargo

- External
 - (2) external cargo hooks
 - 10,000 lb single hook (forward or aft hook)
 - 15,000 lb dual-hook
 - Cabin accessible
 - Air-drop capability
- Internal
 - 300 lb/ft² floor loading capacity for up to 20,000 lb of internal cargo
 - Floor tie-down fittings within cabin and ramp
 - Flip, roller rails for cargo loading
 - 2,000 lb cargo winch, 150 ft cable
 - (2) 463L half-pallets, (4) 40 in x 48 in warehouse pallets, and other loading as available
 - Light Tactical Vehicles - Several vehicles can be loaded internally, including the M151 Jeep (top cover removed and windshield folded), and the M274 Mechanical Mule. The U.S. Marine Corps and The U.S. Special Operations Command are designing a family of Internally Transportable Vehicles (ITV) sized to be carried inside of the V-22.

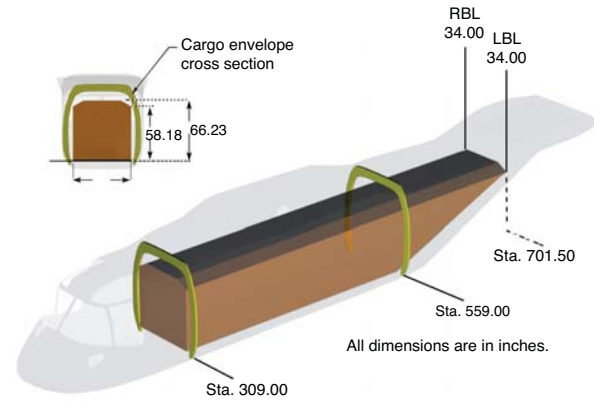
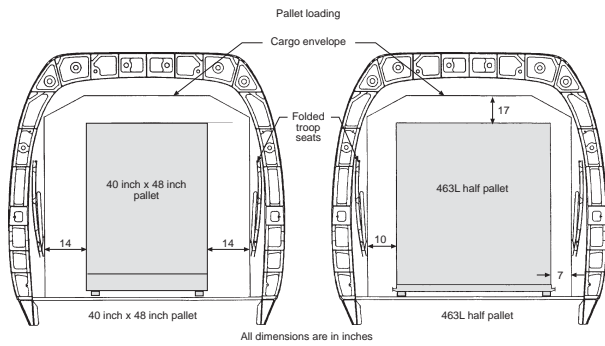

Note: Dimensions define the shape that must be clear from sta. 309 to sta. 559, and from sta. 559 to 701.5 in the aft fuselage, with the ramp floor level with the cabin floor.

Cabin Volume



Vertical insertion/extraction

- Rescue hoist at rear ramp
 - Electric hoist, 250 ft usable cable
 - 600 lb capacity, > 250 fpm speed
 - Emergency cable cutting system
- Two fast rope attachments in cabin area
- Parachute static lines



Flight Control System

The V-22 incorporates both fixed-wing and rotary-wing flight controls in the electronic, fly-by-wire system. The Flight Control System (FCS) provides control throughout the flight envelope, as well as a smooth transition between helicopter and airplane flight modes.

The figures below present the locations and numbers of hydraulic actuators used in controlling the V-22. It also includes the functions of the flight control surfaces.

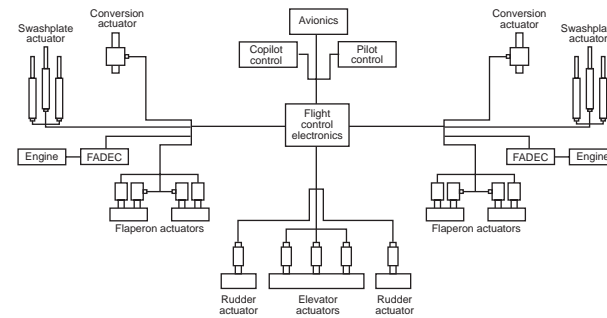

Flight Control System Block Diagram

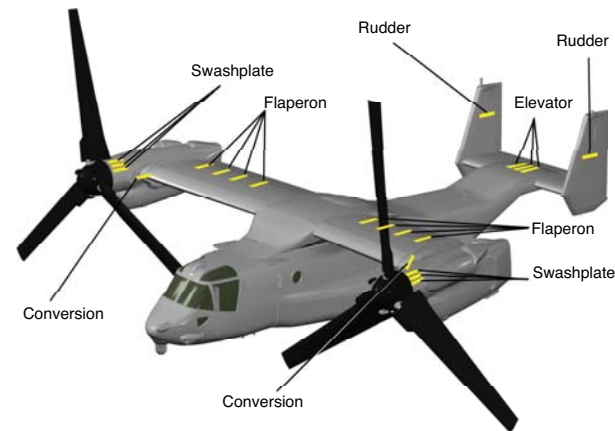

Hydraulic Flight Control Actuators

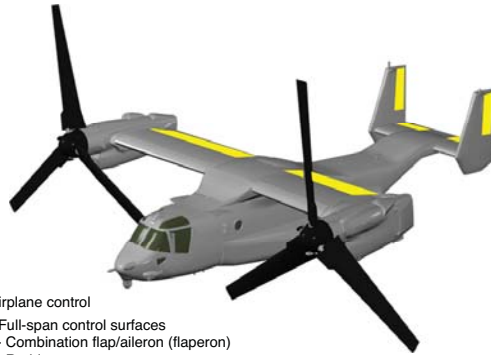

Airplane control

- Full-span control surfaces
 - Combination flap/aileron (flaperon)
 - Rudder
 - Elevator
- Proprotor pitch controlled automatically through (TCL) input
 - Reduces flapping
 - Maintains constant RPM



Helicopter control

- Proprotor blades are primary flight control
- Thrust Control Lever (TCL) is throttle and collective pitch

Flight Control Mechanisms

The primary flight controls consist of:

- Cyclic sticks located in front of each cockpit crew seat
- Thrust control levers mounted to the left of each seat
- Floor-mounted directional pedals
- Proprotor nacelle angle control (thumbwheel on TCL)

The pilot and copilot controls are mechanically connected under the cockpit floor by push-pull control tubes. Sensors detect control displacements in each of three axes and relay the information directly to the digital flight control computers. These high-speed computers provide commands directly to the aircraft's flight control actuators. The rudder pedals also control the nose wheel steering and wheel brake systems.

The following figures illustrate the effect of each pilot's control input on aircraft motions in both helicopter and airplane modes.

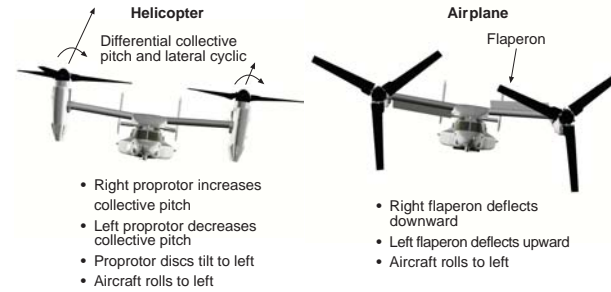

Lateral Control Input (Left Stick Shown)

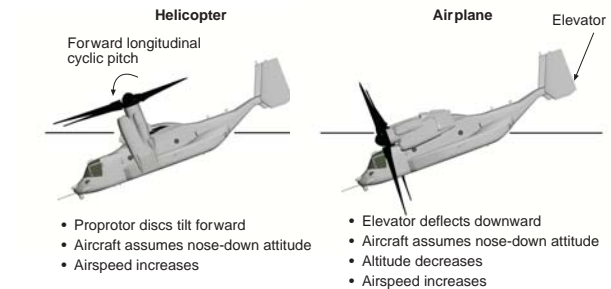

Longitudinal Control Input (Forward Stick Shown)

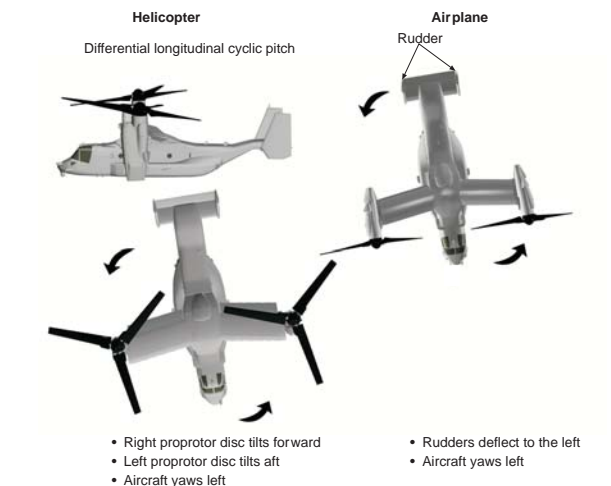

Directional Control Input (Left Pedal Shown)

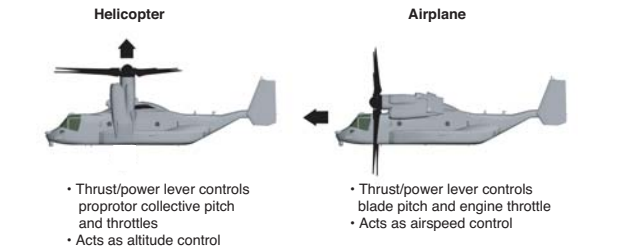

Thrust/Power Input (Forward/Increase Shown)

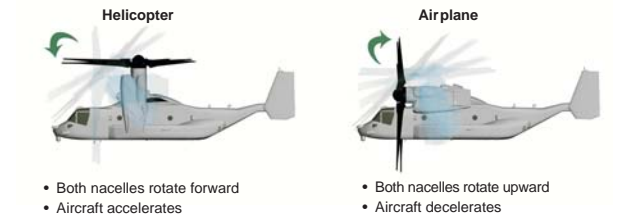

Nacelle Control Input

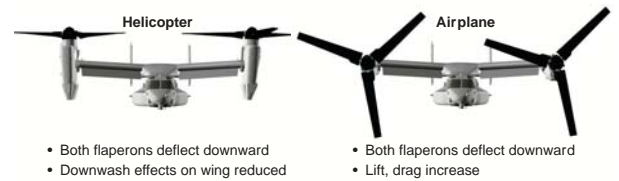

Flap Input

The V-22 can perform a complete transition from helicopter mode to airplane mode in as little as 16 seconds. The aircraft can fly at any degree of nacelle tilt within its conversion corridor (the range of permissible airspeeds for each angle of nacelle shift).

During vertical takeoff, conventional helicopter controls are utilized. As the tiltrotor gains forward speed (between 40 to 80 knots), the wing begins to produce lift and the ailerons, elevators, and rudders become effective. The rotary-wing controls are then gradually phased out by the flight control system. At approximately 100 to 120 knots, the wing is fully effective and pilot control of cyclic pitch of the proprotors is locked out.

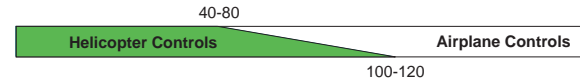

The conversion corridor is very wide (approximately 100 knots) in both accelerating and decelerating flight. This wide corridor results in a safe and comfortable transition, which is free of the threat of wing stall.

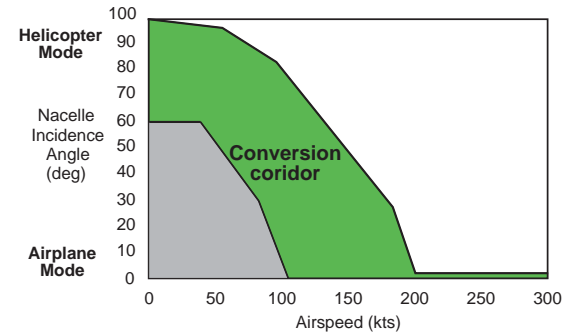

Conversion Corridor

Hydraulic Systems

There are three independent 34.5 MPa (5,000 psi) hydraulic systems. Systems 1 and 2 are designated as primary and are dedicated to the flight control systems.

System 3 is designated as the utility hydraulic system, and also powers the following equipment/functions:

- Landing gear (extend/retract)
- Ramp/door
- Main wheel brakes
- Nose wheel steering
- Engine start
- Cargo winch
- Engine Air Particle Separator (EAPS)
- Wing stow
- Rotor brake
- Retractable aerial refuel probe

In the event of failure in the primary hydraulics system (Systems 1 and 2), System 3 provides pressure to the swashplate and conversion actuators (providing additional redundancy). For maintenance and ground operations, System 3 is powered by the APU (prior to rotor spin up).

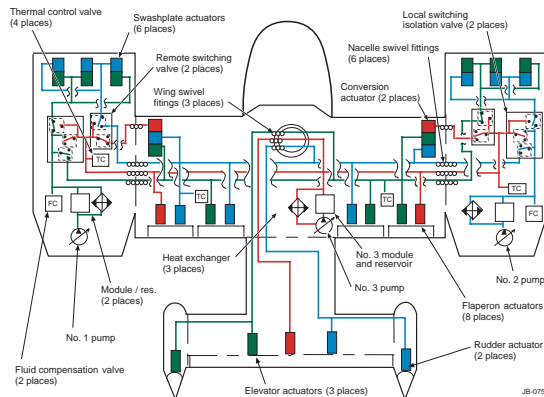

Flight Control Hydraulic System (Systems 1 & 2)

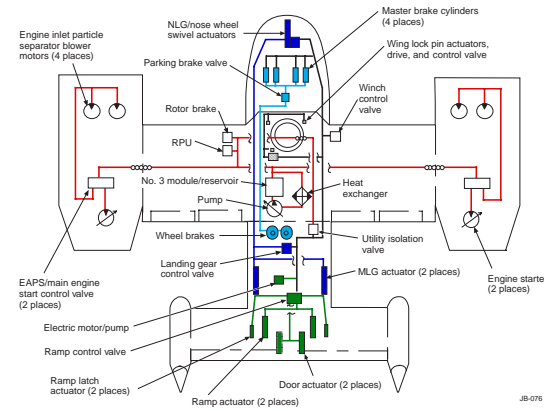

Utility Hydraulic System (System 3)

Electrical Systems

The V-22 is equipped with a redundant power generation system capable of producing up to 240 total kVA. The system consists of:

- Two 40 kVA constant frequency generators
- Two 50/80 kVA variable frequency generators
- Three AC to DC regulated converters
- One 24 ampere-hour sealed lead acid battery

Ground power may be provided by external AC power unit or by the on-board APU.

The AC power is distributed as 115/200 volt (3-phase), and 115-volt, (single phase). There are four utility electrical outlets provided in the cabin.

The V-22 DC electrical system supplies 24/28 Volts Direct Current (VDC) to the flight-essential systems, the primary aircraft DC electrical loads, the electrical components powered from the essential bus, and the electrical components powered from the battery bus.

Fuel System

The fuel system is integrated into the wing and fuselage systems and consists of:

- Two wing feed tanks – one in each outboard section of each wing
- Two sponson tanks – one in each forward sponson bay
- Eight wing tanks – 4 in each wing between the wing feed tank and the mid-wing area.
- Retractable aerial refueling probe

For extended range operations, up to (3) mission auxiliary tanks (MAT) in the cabin, or (2) MAT and an aft sponson tank can be used. Electrical, plumbing, and vent connections are provided for the installation of the internal cabin tanks.

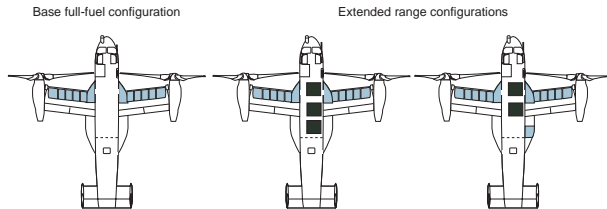

V-22 Fuel Configuration

Configuration	Number of Tanks	Usable Fuel per Tank		Fuel Weight per Tank	
		(gal)	(liters)	(lb)	(kg)
Wing Feed Tanks	2	88	334	600	272
Fwd Sponsons	2	478	1,809	3,250	1,474
Wing Tanks	8	74	278	500	227
Total - Standard	All Tanks	1,721	6,513	11,700	5,307
Mission Aux Tanks	Up to 3	430	1,628	2,924	1,326
Rt Aft Sponson (Optional)	1	316	1,197	2,150	975
		2,037	7,710	13,850	6,282

Fuel System Capacities (JP-5 or JP-8)

Environmental Control System

The V-22 incorporates a modern Environmental Control System (ECS) to provide for crew and passenger health, safety, and comfort over a wide range of aircraft and environmental operating conditions. It also protects the avionics/mission systems during operation in extreme climatic conditions as well as under thermal stress.

The ECS includes:

- Pneumatic power system
- Onboard Oxygen Generating System (OBOGS)
- Onboard Inert Gas Generating System (OBIGGS)
- Cockpit and cabin heating and cooling
- Avionics air conditioning
- A pneumatic wing deicing system

The pneumatic system supplies low-pressure (3.5 kg/sq cm, or 50 lb/sq in) compressed air to the ECS. The ECS distributes conditioned air to the cockpit and cabin, and partially conditioned air to the O₂N₂ concentrator, wing deicing boots, and avionics cooling air particle separators. Compressed air for the pneumatic system is supplied by the Shaft-Driven Compressor (SDC). The SDC is mounted on the mid-wing gearbox and operates when the APU or engines are running.

Cockpit and Avionics

The V-22 Integrated Avionics System (IAS) is a fully integrated avionics suite using a combination of off-the-shelf equipment and specially developed hardware and software. The functionality integrated into this system is as follows:

- *Controls and Displays*

Provides aircrew and maintenance personnel with the resources to monitor cockpit information and control aircraft functions.

- *Mission Computers*

Provides for dual-redundant processing using primary and backup advanced mission computers that process and control all functions of the IAS.

- *Navigation*

Provides primary navigation data. This data is gathered from the inertial navigation sensors and radio navigation sensors.

Navigation data includes: position, heading, altitude, geographic frame velocities, radar altitude, radio navigation (data such as distance and bearing to ground stations), and marker beacon station passage.

An optional enhanced suite can include Terrain Following/Terrain Avoidance (TF/TA) Multimode Radar and traffic collision avoidance system (TCAS).

- *Communications*

Provides for internal and external radio control and intercommunications, VHF/UHF radio communication, SATCOM, and IFF.

- *Turreted Forward Looking Infra-Red System*

Provides for reception of infrared energy and its conversion to video signals (to assist the aircrew in piloting and navigation).

- *Digital Map*

Provides a real-time, color, moving map imagery on the multi-function displays. It may be operated independently by both operators. The aircraft's position is shown with respect to the display, and multiple overlay options are available.

- *Electronic Warfare Suite*

Provides detection and crew notification of missiles, radars, and laser signals that pose a threat to the aircraft.

The suite also includes dispensers for expendable countermeasures.

An optional enhanced suite includes active jamming systems, additional countermeasure launchers, and other systems.

- *Interface Units (IUs)*

Provides the capability to control and monitor the aircraft and its avionics systems that are incompatible with the MIL-STD-1553 data bus protocol.

The IUs provide the capability to communicate with ARINC-429, RS-422, and other discrete signal devices.

- *Vibration, Structural Life, Engine Diagnostics (VSLED)*

VSLED is an onboard system designed to capture and record vital aircraft data for enhanced safety and maintenance. An active vibration suppression system is also onboard to detect and suppress cockpit and cabin vibration.

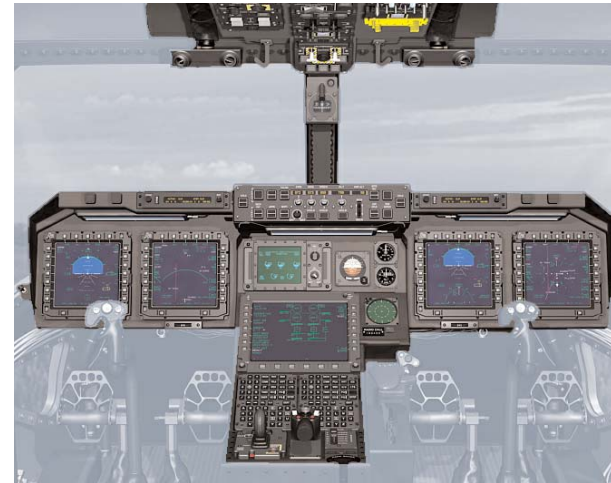

V-22 Cockpit Instrument Panel

Shipboard Compatibility

The V-22 is designed to operate within the space limitations imposed by the flight deck, hangar deck, and aircraft elevators of the U.S. Navy's amphibious assault ships as well as compatible with the limited maintenance facilities aboard these ships.



Hangar Deck

Elevator



Positioning on Flight Deck

Movement onto Flight Deck

The basic requirements, which support this capability, include:

- Operating from a launch and recovery spot located next to the island superstructure of an amphibious assault ship
- Corrosion resistant composite rotor blades, hubs, and airframe
- Marinized engines
- Electromagnetic Environmental Effects (E3) protection
- Compact airframe footprint for easy stowage
- Tiedowns incorporated for winds up to 60 knots in stowed configuration and for 100 knot heavy weather configuration
- Blade fold/wing stow in and up to 45 knot winds
- Many maintenance tasks to be accomplished in the folded/stowed configuration.



V-22 Landing Aboard Amphibious Assault Ship



Blade Fold/Wing Stow Sequence

Survivability Features

The V-22 design has numerous inherent and intentionally designed survivability features, as itemized below.

Reduced Susceptibility

- Performance
 - Speed
 - Range
 - Altitude
 - Maneuverability
- Defensive Warning System
- Threat Warning and Countermeasures
- Tactics
 - Night
 - Low-level
 - All-weather
- Signature Reduction
 - Infrared - 95% reduction compared to CH-46
 - Acoustic - 75% reduction compared to CH-46
 - EMCON
 - Visual

Reduced Vulnerability

- Systems Protection
 - Redundancy
 - Isolation
 - Separation
 - Armor
- One Engine Inoperative Capability
- Dry Bay and Engine Fire Suppression
- Ballistic Tolerance
 - Composite Structure
 - Hydraulic Ram Protection
 - Self-sealing Fuel Bladders
 - Nitrogen-Inerted Fuel System

Improved Crashworthiness

- Energy Management
 - "Broomstraw" Blade Failure
 - Mass Remote Design
 - Controlled Wing Failure
 - Anti-plow Bulkhead
- Crashworthy Fuel System
- Ditching Buoyancy, Stability and Emergency Egress
- Stroking Seats and Shoulder Harness for Troops and Crew



Operating Environment

The V-22 has been designed to operate within the specified set of environmental conditions summarized below.

Ambient Temperature	-65° F(-54°C) to 125° F (+52°C)
Pressure Altitude	Method 520.0, Procedure III, MIL-STD-810; Temperature, Humidity, Vibration, Altitude
Humidity	Method 507.3 of MIL-STD-810; Humidity 45% RH at 21°C 95% RH at 38°C 80% RH at 52°C 20% RH at 71°C
Tropical Exposure	Combination of Temperature, Humidity, Rain, Solar Radiation, and Sand/Dust requirements allow the V-22 to operate in a Tropical Environment.
Vibration	Method 514.3, Procedure I, MIL-STD-810; Vibration
Shock Method	516.3, Procedure I & V, MIL-STD-810; Shock
Sand and Dust	Method 510.1, Procedure I, MIL-STD-810; Sand and Dust Particle concentrations of 1.32 X 10 ⁻⁴ pounds per cubic foot in multidirectional winds of 45 knots. The upper nacelle blower will withstand particle concentrations of 4.0 X 10 ⁻⁶ pounds per cubic foot.
Water Resistance	Method 512.3 of MIL-STD-810; Leakage (Immersion)
Mold Growth	Method 508.4 of MIL-STD-810; Fungus
Salt Mist	Method 509.2, MIL-STD-810; Salt Fog
Salt Spray	Sea salt fallout up to 200 parts per billion. The aircraft's components operate reliably after exposure to Method 510.1, Procedure I, MIL-STD-810

NBC	Power, wiring, and connections provided for seven stations for NBC protective garments and masks (three are located in the cockpit and four located in the cabin).
Exposure to Solar Radiation	Radiant energy at a rate of 355 BTU per square foot per hour or 104 watts per square foot (1120 W/M ²).
Bird Strike	The windshield is capable of resisting the impact of a three pound bird at 275 knots.
Rain and Wind	8 inches per hour minimum. The aircraft is designed to withstand damage in winds of: up to 60 knots with wing ready for flight and blades folded; up to 100 knots with both wing and blades ready for flight; up to 60 knots from any direction with blades folded and wing stowed.
Hail Strike	Able to withstand 1 inch hail stones in multiple aircraft conditions - in-flight, take off and landing, taxi and hover, and parked.
Snow	Snowload capability of 20 pounds per square foot on horizontal surfaces. This is assuming aircraft is not operating and will be cleared of snow between storms.
Icing	Operation at full mission capability in icing conditions, ice fog, and hoarfrost up to moderate intensities down to -20°C ambient temperatures.
Lightning	No Category 1 effects due to damage to or temporary upset of Category 1 CFE and GFE from a severe lightning attachment with a 200 kAmp first return stroke with a peak rise time of 1.4x10 ⁻⁶ Amp/sec to the air vehicle. No Category 2 effects due to damage to or permanent upset of category 2 CFE or due to damage to Category 2 GFE from a lightning attachment with a 50 kAmp first return stroke with peak rise time of 3.5x10 ⁻⁶ Amps/sec to the air vehicle.

V-22 Flight Performance

The V-22 is capable of sustained cruise speeds in excess of 275 kts and an unprecedented V/STOL aircraft mission radius. Standard day capabilities are shown in the figures below.

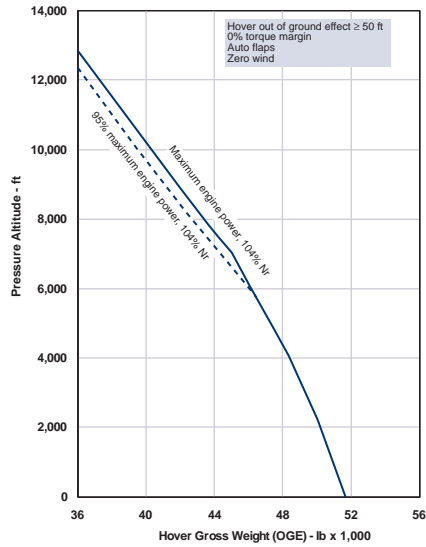

Hover Performance

V-22 Standard Day Hover Envelope (OGE)

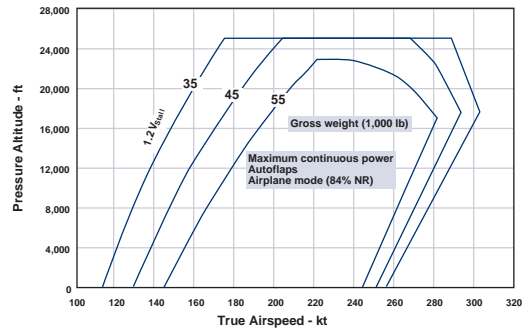

Cruise Flight Envelope

V-22 Airplane Mode Flight Envelope (Standard Day)

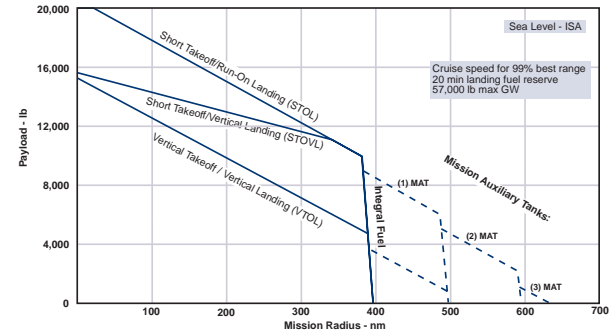

Internal Payload Mission

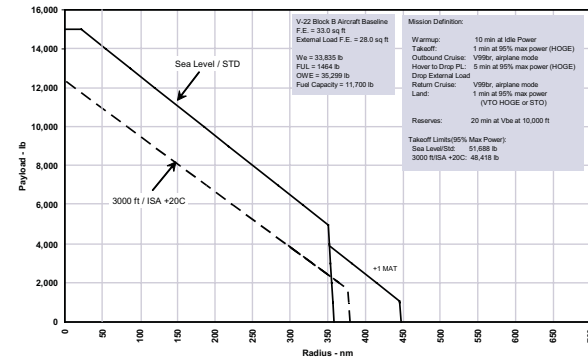

External Payload Mission

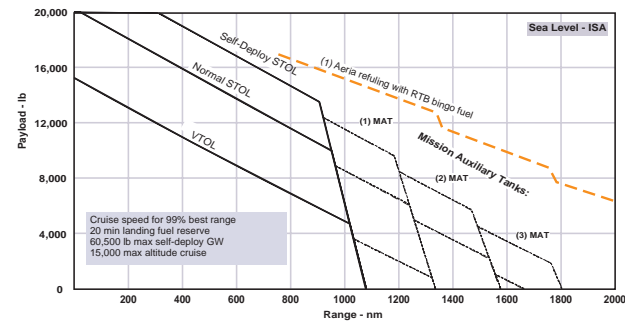

Self-Deployment Mission

Multiservice Configurations



MV-22 U.S. Marine Corps

The V-22 is being developed and produced utilizing incremental, time-phased upgrades ("Blocks").

- Block A - safe and operational
- Block B - combat capability improvements plus enhanced maintainability
- Block C - mission enhancements and upgrades

Block B will be the first Block to deploy.

Inherent features

- Composite/aluminum airframe
- Triple redundant fly-by-wire flight controls
- Rolls-Royce AE1107C engines
- Interconnect drive shaft
- 5000 psi hydraulic system
- 240 kVA electrical capacity
- Blade fold/wing stow
- Anti-ice and deice systems
- Vibration, structural life, and engine diagnostics
- Engine air particle separators
- Loading ramp
- Aerial refueling probe
- 5.7' W x 5.5' H x 20.8' L cabin
- Onboard oxygen and inert gas generating systems (OBOGS/OBIGGS)

Mission equipment

- Single and dual point external cargo hooks
- Advanced cargo handling system
- Fast rope
- Rescue hoist
- Parachute static lines
- Ramp mounted defensive weapon system
- Up to (3) mission auxiliary fuel tanks

Avionics

- Dual avionics MIL-STD-1553B data buses
- Dual 64-bit mission computers
- Night Vision Goggle (NVG) compatible, multifunction displays
- Inertial navigation system (3)
- Global positioning system
- Digital map system
- SATCOM
- VOR/ILS/ marker beacon
- Radar altimeter
- FM homing system
- Dual VHF/UHF/AM/FM radios
- Digital intercommunications system
- Turreted Forward Looking Infra-Red (FLIR) system
- Identification, Friend or Foe (IFF) transponder
- Tactical Air Navigation (TACAN) system
- Troop commander's communication station
- Flight incident recorder
- Missile/radar warning and laser detection





CV-22 U.S. Special Operations Command

The CV-22 is being developed and produced in parallel with the MV-22 configuration in incremental upgrades ("Blocks")

- Block 0 - MV-22 Block A plus basic special operations capabilities
- Block 10 - MV-22 Block B plus improved special operations capabilities
- Block 20 - MV-22 Block C plus mission enhancements and upgrades

MV-22 Block B and CV-22 Block 10 have the same propulsion system, and 90% common airframe. The primary differences are in the avionics systems.

CV-22 unique equipment

- Multimission Advanced Tactical Terminal (MATT) integrated with digital map, survivor locator equipment, and the electronic warfare suite
- Multimode Terrain Following/Terrain Avoidance (TF/TA) radar
- Advanced, integrated defensive electronic warfare suite
 - Suite of Integrated RF Countermeasures (SIRFC)
 - Directed IR Countermeasures (DIRCM)
- Additional tactical communications with embedded communication security
- Upgraded intercommunications
- Computer and digital map upgrades
- RF interference canceller system
- Flight engineer seating accommodation
- Crash position indicator

V-22 Top Tier Suppliers

Supplier	System
BAE	Flight control system
EFW	Digital map, MFD, DEU
Engineering Fabrics	Fuel cells
General Dynamics	Mission computer
Honeywell	ECS system and components, LWINS, VF generator, CDS, FDP, TCAS, SDC, IR suppressor, heat exchanger
ITT	AN/ALQ-211 (SIRFC)
Moog	Flight control actuators, vibration suppression actuators
MRA	Structural components
Northrup Grumman	DIRCM
Raytheon	FLIR, MMR, MAGR, IFF, mission planning, maintenance system
Rolls Royce	Engines
Smiths	Standby altimeter, AIU, rudder actuator, CF generator, flight incident recorder, lighting controllers, forward cabin control station, transmission blowers
Vought	Empennage, fiber placement skins

Studies and Analyses

Numerous major studies and analyses have shown that the V-22 is more cost and operationally effective than any helicopter (including compound helicopter designs), or any combination of helicopters.

Compared to a range of current and advanced helicopter designs:

- The V-22 has superior speed, range and survivability:
 - Increases the tactical options available to the operational commander
 - Dramatically reduces friendly force casualties in post-assault ground operations
- When equal lift capability aircraft fleets are considered:
 - Significantly fewer V-22 were required to accomplish the specified missions.
 - Likewise, proportionately fewer support assets and personnel were required.
- When equal cost aircraft fleets are considered:
 - The V-22 fleet is more effective than any of the helicopter alternatives.
 - Lower through-life costs of the tiltrotor

V-22 offers best value for the money.

For example, in a recent *V-22 in GWOT Scenario*, the disparity in required mission resources was evident. The V-22 needed about one-quarter of the resources required of conventional helicopters. Specifically, the asset requirements were:

- 3 V-22s, 1 strategic airlift aircraft, 1 strategic tanker, 3 combat service support aircraft, and 1 support base

VS

- 5 helicopters, 7 tactical tankers, 9 strategic airlift aircraft, 12 combat service support aircraft, and 4 support bases

Reduced complexity increases the probability of success, while decreasing requirements and total mission cost. The V-22 significantly reduces the logistical complexity to accomplish the mission.

Study	Author	Funded By:	Date
Cost and Operational Effectiveness of the JVX for Airlift of Special Operations Forces	ANSER	USG	1984/1987
An Evaluation of the JVX Aircraft for USMC Assault and CSAR Mission	CNA	USG	1985
MV-22 Combat Effectiveness Analysis I		Bell-Boeing	1987
Assessment of Alternatives for the V-22 Assault Aircraft Program	IDA	USG	1990
MV-22 Combat Effectiveness Analysis II	BDM	Bell-Boeing	1990
Medium Lift Replacement (MLR) Study	NAVAIR	USG	1991
Effectiveness of Tiltrotor Support to Ground Combat	Lawrence Livermore	Bell-Boeing	1991
Medium Lift Replacement (MLR) Cost and Operational Effectiveness Analysis	CNA	USG	1993
USMC MLR Operational Effectiveness Analysis	BDM	Bell-Boeing	1993
Special Operations Command COEA of the Advanced Multi-Mission Vertical Lift Aircraft (JMV-X)	ANSER	USG	1993
Medium Lift Replacement (MLR) Cost and Operational Effectiveness Analysis, Supplemental Analysis	BDM	USG	1994
V-22 Multimission Applications for the U.K.	DERA/TRW	Bell-Boeing	1999
Quick Look Study	CNA	USG	2001
V-22 and the Global War on Terrorism (GWOT) - Phase I: Prevent/Retaliate	ANSER	Bell-Boeing	2002
V-22 GWOT - Phase II: Respond	ANSER	Bell-Boeing	2003
V-22 GWOT - Phase III: Costing and Total Force	ANSER	Bell-Boeing	2003
V-22 GWOT - Phase IV: Personnel Recovery Total Force	ANSER	Bell-Boeing	2005
V-22 GWOT - Phase V: Relevance of V-22 Capability to Naval Applications in the GWOT	ANSER	Bell-Boeing	2006
UK V-22: To show the relevance of V-22 capabilities to current and emerging UK Defence requirements	MASS	Bell-Boeing	2005
V-22 GWOT - Phase VI: V-22 Relevance to USSOCOM Current and Emerging Roles and Missions	ANSER	Bell-Boeing	2007

Flight Crew and Maintenance Mechanic Training

The V-22 Training System is comprised of fully integrated aircrew and maintainer training and training devices. Safety, proper procedures, and effectiveness are stressed within all training courses. They are designed to meet the needs of initial entry and transition personnel. The Bell-Boeing training strategy takes advantage of a full suite of training services and equipment developed specifically for the V-22. These include:

- A Federal Aviation Agency (FAA) Level-D equivalent full flight simulator (FFS),
- Level 7 equivalent Flight Training Device (FTD),
- Suite of Part Task Maintenance Trainers
- Interactive audio/video computer-based training (CBT) devices, and
- Computer-based presentation system supporting instructor-led training.



40



Multimission Capabilities

The V-22 is a highly flexible, multipurpose aircraft capable of performing many missions. The U.S. Government, Bell-Boeing, and commercial analysis companies have evaluated the suitability and effectiveness of tiltrotor variants for over 30 different potential missions. These potential missions are summarized in the following list:

- | | |
|-----------------------------------|---|
| Special Warfare | <ul style="list-style-type: none"> • Special Operations • Electronic Warfare |
| Sea Control | <ul style="list-style-type: none"> • Anti-Submarine Warfare • Anti-Surface Ship Warfare • Maritime Interception Operations • Mine Warfare |
| Theater Operations | <ul style="list-style-type: none"> • Assault Medium Lift • Tactical Mobility • Advanced Rotary Wing Attack • Gunship/Close Air Support • Aerial Refueling • Combat Rescue |
| Recovery and Civil Support | <ul style="list-style-type: none"> • Search and Rescue • Medical Evacuation • Joint Emergency Evacuation of Personnel • Civil Disaster Response |
| Communications | <ul style="list-style-type: none"> • Forward Air Control • Surface, Subsurface, and Surveillance Coordination • Over-the-Horizon Targeting • Surface Combatant Airborne Tactical System |
| Intelligence | <ul style="list-style-type: none"> • Observation • Armed Reconnaissance • Airborne Early Warning-Surface Combatants • Signal Intelligence • Battle Group Surveillance Intelligence |
| Transport | <ul style="list-style-type: none"> • Fleet Logistics • Carrier/Surface Ship Onboard Delivery • Operational Support Airlift • Mid-Air Retrieval System • Light Intratheater Transport • National Executive Transport |
| Support | <ul style="list-style-type: none"> • Missile Site Support • Range Support |

